

DENON

COMPACT DISC PLAYER

DCD-710AE

Owner's Manual

Bedienungsanleitung

Manuel de l'Utilisateur

Manuale delle istruzioni

Manual del usuario

Gebruiksaanwijzing

Bruksanvisning

SAFETY PRECAUTIONS



CAUTION
RISK OF ELECTRIC SHOCK
DO NOT OPEN



CAUTION:
TO REDUCE THE RISK OF ELECTRIC SHOCK, DO NOT REMOVE COVER (OR BACK). NO USER-SERVICEABLE PARTS INSIDE. REFER SERVICING TO QUALIFIED SERVICE PERSONNEL.

The lightning flash with arrowhead symbol, within an equilateral triangle, is intended to alert the user to the presence of uninsulated "dangerous voltage" within the product's enclosure that may be of sufficient magnitude to constitute a risk of electric shock to persons.

The exclamation point within an equilateral triangle is intended to alert the user to the presence of important operating and maintenance (servicing) instructions in the literature accompanying the appliance.

WARNING:
TO REDUCE THE RISK OF FIRE OR ELECTRIC SHOCK, DO NOT EXPOSE THIS APPLIANCE TO RAIN OR MOISTURE.

CLASS 1 LASER PRODUCT
LUOKAN 1 LASERLAITE
KLASS 1 LASERAPPARAT

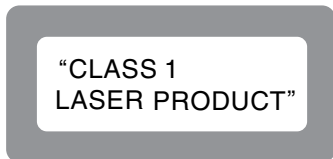

- ADVARSEL:** USYNLIG LASERSTRÅLING VED ÅBNING, NÅR SIKKERHEDSAFBRYDERE ER UDE AF FUNKTION. UNDGÅ UDSÆTTELSE FOR STRÅLING.
- VAROITUS!** LAITTEEN KÄYTTÄMINEN MUULLA KUIN TÄSSÄ KÄYTTÖOHJEESSA MAINITULLA TAVALLA SAATTAA ALTISTAA KÄYTTÄJÄN TURVALLISUUSLUOKAN 1 YLITTÄVÄLLE NÄKYMÄMTTÖMÄLLE LASERSÄTEILYLLE.
- WARNING:** OM APPARATEN ANVÄNDS PÅ ANNAT SÄTT ÄN I DENNA BRUKSANVISNING SPECIFICERATS, KAN ANVÄNDAREN UTSÄTTAS FÖR OSYNLIG LASERSTRÅLNING SOM ÖVERSKRIDER GRÄNSEN FÖR LASERKLASS 1.



ATTENZIONE: QUESTO APPARECCHIO E' DOTATO DI DISPOSITIVO OTTICO CON RAGGIO LASER. L'USO IMPROPRIO DELL'APPARECCHIO PUO' CAUSARE PERICOLOSE ESPOSIZIONI A RADIAZIONI!

IMPOTANT SAFETY INSTRUCTIONS

1. Read these instructions.
2. Keep these instructions.
3. Heed all warnings.
4. Follow all instructions.
5. Do not use this apparatus near water.
6. Clean only with dry cloth.
7. Do not block any ventilation openings. Install in accordance with the manufacturer's instructions.
8. Do not install near any heat sources such as radiators, heat registers, stoves, or other apparatus (including amplifiers) that produce heat.
9. Protect the power cord from being walked on or pinched particularly at plugs, convenience receptacles, and the point where they exit from the apparatus.
10. Only use attachments/accessories specified by the manufacturer.
11. Use only with the cart, stand, tripod, bracket, or table specified by the manufacturer, or sold with the apparatus. When a cart is used, use caution when moving the cart/apparatus combination to avoid injury from tip-over.
12. Unplug this apparatus during lightning storms or when unused for long periods of time.
13. Refer all servicing to qualified service personnel. Servicing is required when the apparatus has been damaged in any way, such as power-supply cord or plug is damaged, liquid has been spilled or objects have fallen into the apparatus, the apparatus has been exposed to rain or moisture, does not operate normally, or has been dropped.
14. Batteries shall not be exposed to excessive heat such as sunshine, fire or the like.



CAUTION:

To completely disconnect this product from the mains, disconnect the plug from the wall socket outlet. The mains plug is used to completely interrupt the power supply to the unit and must be within easy access by the user.

VORSICHT:

Um dieses Gerät vollständig von der Stromversorgung abzutrennen, ziehen Sie bitte den Stecker aus der Wandsteckdose. Der Netzstecker wird verwendet, um die Stromversorgung zum Gerät völlig zu unterbrechen; er muss für den Benutzer gut und einfach zu erreichen sein.

PRECAUTION:

Pour déconnecter complètement ce produit du courant secteur, débranchez la prise de la prise murale. La prise secteur est utilisée pour couper complètement l'alimentation de l'appareil et l'utilisateur doit pouvoir y accéder facilement.

ATTENZIONE:

Per scollegare completamente questo prodotto dalla rete di alimentazione elettrica, scollegare la spina dalla relativa presa a muro.

La spina di rete viene utilizzata per interrompere completamente l'alimentazione all'unità e deve essere facilmente accessibile all'utente.

PRECAUCIÓN:

Para desconectar completamente este producto de la alimentación eléctrica, desconecte el enchufe del enchufe de la pared. El enchufe de la alimentación eléctrica se utiliza para interrumpir por completo el suministro de alimentación eléctrica a la unidad y debe de encontrarse en un lugar al que el usuario tenga fácil acceso.

WAARSCHUWING:

Om de voeding van dit product volledig te onderbreken moet de stekker uit het stopcontact worden getrokken. De netstekker wordt gebruikt om de stroomtoevoer naar het toestel volledig te onderbreken en moet voor de gebruiker gemakkelijk bereikbaar zijn.







FÖRSIKTIHETSMÅTT:

Koppla loss stickproppen från eluttaget för att helt skilja produkten från nätet. Stickproppen används för att helt bryta strömförsörjningen till apparaten, och den måste vara lättillgänglig för användaren.

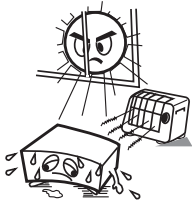
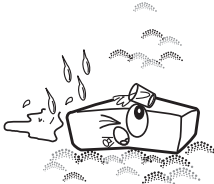
CAUTION:

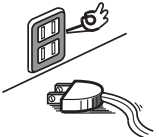
USE OF CONTROLS OR ADJUSTMENTS OR PERFORMANCE OF PROCEDURES OTHER THAN THOSE SPECIFIED HEREIN MAY RESULT IN HAZARDOUS RADIATION EXPOSURE. THIS PRODUCT SHOULD NOT BE ADJUSTED OR REPAIRED BY ANYONE EXCEPT PROPERLY QUALIFIED SERVICE PERSONNEL.

NOTE ON USE / HINWEISE ZUM GEBRAUCH / OBSERVATIONS RELATIVES A L'UTILISATION / NOTE SULL'USO / NOTAS SOBRE EL USO / ALVORENS TE GEBRUIKEN / OBSERVERA ANGRÄENDE ANVÄNDNINGEN

 <ul style="list-style-type: none"> • Avoid high temperatures. Allow for sufficient heat dispersion when installed in a rack. • Vermeiden Sie hohe Temperaturen. Beachten Sie, dass eine ausreichende Belüftung gewährleistet wird, wenn das Gerät auf ein Regal gestellt wird. • Eviter des températures élevées. Tenir compte d'une dispersion de chaleur suffisante lors de l'installation sur une étagère. • Evitate di esporre l'unità a temperature elevate. Assicuratevi che vi sia un'adeguata dispersione del calore quando installate l'unità in un mobile per componenti audio. • Evite altas temperaturas. Permite la suficiente dispersión del calor cuando está instalado en la consola. • Vermijd hoge temperaturen. Zorg er bij installatie in een audiorack voor, dat de door het toestel geproduceerde warmte goed kan worden afgevoerd. • Undvik höga temperaturer. Se till att det finns möjlighet till god värmeavledning vid montering i ett rack. 	 <ul style="list-style-type: none"> • Keep the unit free from moisture, water, and dust. • Halten Sie das Gerät von Feuchtigkeit, Wasser und Staub fern. • Protéger l'appareil contre l'humidité, l'eau et la poussière. • Tenete l'unità lontana dall'umidità, dall'acqua e dalla polvere. • Mantenga el equipo libre de humedad, agua y polvo. • Laat geen vochtigheid, water of stof in het apparaat binnendringen. • Utsätt inte apparaten för fukt, vatten och damm. 	 <ul style="list-style-type: none"> • Do not let foreign objects into the unit. • Lassen Sie keine fremden Gegenstände in das Gerät kommen. • Ne pas laisser des objets étrangers dans l'appareil. • Non inserire corpi estranei all'interno dell'unità. • No deje objetos extraños dentro del equipo. • Laat geen vreemde voorwerpen in dit apparaat vallen. • Se till att främmande föremål inte tränger in i apparaten. 	<p>CAUTION:</p> <ul style="list-style-type: none"> • The ventilation should not be impeded by covering the ventilation openings with items, such as newspapers, tablecloths, curtains, etc. • No naked flame sources, such as lighted candles, should be placed on the unit. • Observe and follow local regulations regarding battery disposal. • Do not expose the unit to dripping or splashing fluids. • Do not place objects filled with liquids, such as vases, on the unit. <p>ACHTUNG:</p> <ul style="list-style-type: none"> • Die Belüftung sollte auf keinen Fall durch das Abdecken der Belüftungsöffnungen durch Gegenstände wie beispielsweise Zeitungen, Tischtücher, Vorhänge o. Ä. behindert werden. • Auf dem Gerät sollten keinerlei direkte Feuerquellen wie beispielsweise angezündete Kerzen aufgestellt werden. • Bitte beachten Sie bei der Entsorgung der Batterien die örtlich geltenden Umweltbestimmungen. • Das Gerät sollte keiner tropfenden oder spritzenden Flüssigkeit ausgesetzt werden. • Auf dem Gerät sollten keine mit Flüssigkeit gefüllten Behälter wie beispielsweise Vasen aufgestellt werden. <p>ATTENTION:</p> <ul style="list-style-type: none"> • La ventilation ne doit pas être gênée en recouvrant les ouvertures de la ventilation avec des objets tels que journaux, rideaux, tissus, etc. • Aucune flamme nue, par exemple une bougie, ne doit être placée sur l'appareil. • Veillez à respecter les lois en vigueur lorsque vous jetez les piles usagées. • L'appareil ne doit pas être exposé à l'eau ou à l'humidité. • Ne pas poser d'objet contenant du liquide, par exemple un vase, sur l'appareil. <p>ATTENZIONE:</p> <ul style="list-style-type: none"> • Le aperture di ventilazione non devono essere ostruite coprendole con oggetti, quali giornali, tovaglie, tende e così via. • Non posizionate sull'unità fiamme libere, come ad esempio candele accese. • Prestate attenzione agli aspetti legati alla tutela dell'ambiente nello smaltimento delle batterie. • L'apparecchiatura non deve essere esposta a gocciolii o spruzzi. • Non posizionate sull'unità alcun oggetto contenente liquidi, come ad esempio i vasi.
 <ul style="list-style-type: none"> • Handle the power cord carefully. Hold the plug when unplugging the cord. • Gehen Sie vorsichtig mit dem Netzkabel um. Halten Sie das Kabel am Stecker, wenn Sie den Stecker herausziehen. • Manipuler le cordon d'alimentation avec précaution. Tenir la prise lors du débranchement du cordon. • Manneggiare il cavo di alimentazione con attenzione. Tenete ferma la spina quando scollegate il cavo dalla presa. • Maneje el cordón de energía con cuidado. Sostenga el enchufe cuando desconecte el cordón de energía. • Hanteer het netsnoer voorzichtig. Houd het snoer bij de stekker vast wanneer deze moet worden aan- of losgekoppeld. • Hantera nätkablen varsamt. Håll i kabeln när den kopplas från el-uttaget. 	 <ul style="list-style-type: none"> • Unplug the power cord when not using the unit for long periods of time. • Wenn das Gerät längere Zeit nicht verwendet werden soll, trennen Sie das Netzkabel vom Netzstecker. • Débrancher le cordon d'alimentation lorsque l'appareil n'est pas utilisé pendant de longues périodes. • Scollegate il cavo di alimentazione quando prevedete di non utilizzare l'unità per un lungo periodo di tempo. • Desconecte el cordón de energía cuando no utilice el equipo por mucho tiempo. • Neem altijd het netsnoer uit het stopkontakt wanneer het apparaat gedurende een lange periode niet wordt gebruikt. • Koppla loss nätkablen om apparaten inte kommer att användas i lång tid. 	 <ul style="list-style-type: none"> • Do not let insecticides, benzene, and thinner come in contact with the unit. • Lassen Sie das Gerät nicht mit Insektiziden, Benzin oder Verdünnungsmitteln in Berührung kommen. • Ne pas mettre en contact des insecticides, du benzène et un diluant avec l'appareil. • Assicuratevi che l'unità non entri in contatto con insetticidi, benzolo o solventi. • No permita el contacto de insecticidas, gasolina y diluyentes con el equipo. • Voorkom dat insecticiden, benzeen of verververdunner met dit toestel in contact komen. • Se till att inte insektsmedel på spraybruk, bensen och thinner kommer i kontakt med apparatens hölje. 	<p>PRECAUCIÓN:</p> <ul style="list-style-type: none"> • La ventilación no debe quedar obstruida por haberse cubierto las aperturas con objetos como periódicos, manteles, cortinas, etc. • No debe colocarse sobre el aparato ninguna fuente inflamable sin protección, como velas encendidas. • A la hora de deshacerse de las pilas, respete la normativa para el cuidado del medio ambiente. • No exponer el aparato al goteo o salpicaduras cuando se utilice. • No colocar sobre el aparato objetos llenos de líquido, como jarros. <p>WAARSCHUWING:</p> <ul style="list-style-type: none"> • De ventilatie mag niet worden belemmerd door de ventilatieopeningen af te dekken met bijvoorbeeld kranten, een tafelkleed, gordijnen, enz. • Plaats geen open vlammen, bijvoorbeeld een brandende kaars, op het apparaat. • Houd u steeds aan de milieuvoorschriften wanneer u gebruikte batterijen wegdoet. • Stel het apparaat niet bloot aan druppels of spatten. • Plaats geen voorwerpen gevuld met water, bijvoorbeeld een vaas, op het apparaat. <p>OBSERVERA:</p> <ul style="list-style-type: none"> • Ventilationen bör inte förhindras genom att täcka för ventilationsöppningarna med föremål såsom tidningar, bordsdukar, gardiner osv. • Inga blottade brandkällor, såsom tända ljus, får placeras på apparaten. • Tänk på miljöaspekterna när du bortskaffar batterier. • Apparaten får inte utsättas för vätska. • Placera inte föremål fyllda med vätska, t.ex. vaser, på apparaten.
	 <p>* (For apparatuses with ventilation holes)</p> <ul style="list-style-type: none"> • Do not obstruct the ventilation holes. • Decken Sie den Lüftungsbereich nicht ab. • Ne pas obstruer les trous d'aération. • Non coprite i fori di ventilazione. • No obstruya los orificios de ventilación. • De ventilatieopeningen mogen niet worden geblokkeerd. • Täpp inte till ventilationsöppningarna. 	 <ul style="list-style-type: none"> • Never disassemble or modify the unit in any way. • Versuchen Sie niemals das Gerät auseinander zu nehmen oder zu verändern. • Ne jamais démonter ou modifier l'appareil d'une manière ou d'une autre. • Non smontare né modificare l'unità in alcun modo. • Nunca desarme o modifique el equipo de ninguna manera. • Dit toestel mag niet gedemonteerd of aangepast worden. • Ta inte isär apparaten och försök inte bygga om den. 	

• DECLARATION OF CONFORMITY

We declare under our sole responsibility that this product, to which this declaration relates, is in conformity with the following standards: EN60065, EN55013, EN55020, EN61000-3-2 and EN61000-3-3. Following the provisions of 2006/95/EC and 2004/108/EC Directive.

• ÜBEREINSTIMMUNGSERKLÄRUNG

Wir erklären unter unserer Verantwortung, daß dieses Produkt, auf das sich diese Erklärung bezieht, den folgenden Standards entspricht: EN60065, EN55013, EN55020, EN61000-3-2 und EN61000-3-3. Entspricht den Verordnungen der Direktive 2006/95/EC und 2004/108/EC.

• DECLARATION DE CONFORMITE

Nous déclarons sous notre seule responsabilité que l'appareil, auquel se réfère cette déclaration, est conforme aux standards suivants: EN60065, EN55013, EN55020, EN61000-3-2 et EN61000-3-3. D'après les dispositions de la Directive 2006/95/EC et 2004/108/EC.

• DICHIARAZIONE DI CONFORMITÀ

Dichiariamo con piena responsabilità che questo prodotto, al quale la nostra dichiarazione si riferisce, è conforme alle seguenti normative: EN60065, EN55013, EN55020, EN61000-3-2 e EN61000-3-3. In conformità con le condizioni delle direttive 2006/95/EC e 2004/108/EC. QUESTO PRODOTTO E' CONFORME AL D.M. 28/08/95 N. 548

• DECLARACIÓN DE CONFORMIDAD

Declaramos bajo nuestra exclusiva responsabilidad que este producto al que hace referencia esta declaración, está conforme con los siguientes estándares: EN60065, EN55013, EN55020, EN61000-3-2 y EN61000-3-3. Siguiendo las provisiones de las Directivas 2006/95/EC y 2004/108/EC.

• EENVORMIGHEIDSVKLAARING

Wij verklaren uitsluitend op onze verantwoordelijkheid dat dit produkt, waarop deze verklaring betrekking heeft, in overeenstemming is met de volgende normen: EN60065, EN55013, EN55020, EN61000-3-2 en EN61000-3-3. Volgens de bepalingen van de Richtlijnen 2006/95/EC en 2004/108/EC.

• ÖVERENSSTÄMMELSESINTYG

Härmed intygas helt på eget ansvar att denna produkt, vilken detta intyg avser, uppfyller följande standarder: EN60065, EN55013, EN55020, EN61000-3-2 och EN61000-3-3. Enligt stadgarna i direktiv 2006/95/EC och 2004/108/EC.

DENON EUROPE
Division of D&M Germany GmbH
An der Landwehr 19, Nettetal,
D-41334 Germany

A NOTE ABOUT RECYCLING:

This product's packaging materials are recyclable and can be reused. Please dispose of any materials in accordance with the local recycling regulations. When discarding the unit, comply with local rules or regulations. Batteries should never be thrown away or incinerated but disposed of in accordance with the local regulations concerning battery disposal. This product and the supplied accessories, excluding the batteries, constitute the applicable product according to the WEEE directive.

HINWEIS ZUM RECYCLING:

Das Verpackungsmaterial dieses Produktes ist zum Recyceln geeignet und kann wieder verwendet werden. Bitte entsorgen Sie alle Materialien entsprechend der örtlichen Recycling-Vorschriften. Beachten Sie bei der Entsorgung des Gerätes die örtlichen Vorschriften und Bestimmungen. Die Batterien dürfen nicht in den Hausmüll geworfen oder verbrannt werden; bitte entsorgen Sie die Batterien gemäß der örtlichen Vorschriften. Dieses Produkt und das im Lieferumfang enthaltene Zubehör (mit Ausnahme der Batterien!) entsprechen der WEEE-Direktive.

UNE REMARQUE CONCERNANT LE RECYCLAGE:

Les matériaux d'emballage de ce produit sont recyclables et peuvent être réutilisés. Veuillez disposer des matériaux conformément aux lois sur le recyclage en vigueur. Lorsque vous mettez cet appareil au rebut, respectez les lois ou réglementations en vigueur. Les piles ne doivent jamais être jetées ou incinérées, mais mises au rebut conformément aux lois en vigueur sur la mise au rebut des piles. Ce produit et les accessoires inclus, à l'exception des piles, sont des produits conformes à la directive DEEE.

NOTA RELATIVA AL RICICLAGGIO:

I materiali di imballaggio di questo prodotto sono riutilizzabili e riciclabili. Smaltire i materiali conformemente alle normative locali sul riciclaggio. Per lo smaltimento dell'unità, osservare le normative o le leggi locali in vigore. Non gettare le batterie, né incenerirle, ma smaltirle conformemente alla normativa locale sui rifiuti chimici. Questo prodotto e gli accessori inclusi nell'imballaggio sono applicabili alla direttiva RAEE, ad eccezione delle batterie.

ACERCA DEL RECICLAJE:

Los materiales de embalaje de este producto son reciclables y se pueden volver a utilizar. Disponga de estos materiales siguiendo los reglamentos de reciclaje de su localidad. Cuando se deshaga de la unidad, cumpla con las reglas o reglamentos locales. Las pilas nunca deberán tirarse ni incinerarse. Deberá disponer de ellas siguiendo los reglamentos de su localidad relacionados con los desperdicios químicos. Este producto junto con los accesorios empaquetados es el producto aplicable a la directiva RAEE excepto pilas.

EEN AANTEKENING MET BETREKKING TOT DE RECYCLING:

Het inpakmateriaal van dit product is recycleerbaar en kan opnieuw gebruikt worden. Er wordt verzocht om zich van elk afvalmateriaal te ontdoen volgens de plaatselijke voorschriften. Volg voor het wegdoen van de speler de voorschriften voor de verwijdering van wit- en bruingoed op. Batterijen mogen nooit worden weggegooid of verbrand, maar moeten volgens de plaatselijke voorschriften betreffende chemisch afval worden verwijderd. Op dit product en de meegeleverde accessoires, m.u.v. de batterijen is de richtlijn voor afgedankte elektrische en elektronische apparaten (WEEE) van toepassing.

OBSERVERA ANGÅENDE ÅTERVINNING:

Produktens emballage är återvinningsbart och kan återanvändas. Kassera det enligt lokala återvinningsbestämmelser. När du kasserar enheten ska du göra det i överensstämmelse med lokala regler och bestämmelser. Batterier får absolut inte kastas i soporna eller brännas. Kassera dem enligt lokala bestämmelser för kemiskt avfall. Denna apparat och de tillbehör som levereras med den uppfyller gällande WEEE-direktiv, med undantag av batterierna.



Pb

Getting Started

Main Features	1
Accessories	2
Cautions on Handling	2
Discs	2
Discs Usable on the DCD-710AE	2
Holding Discs	2
Loading Discs	2
Cautions on Loading Discs	2
Cautions on Handling	3
Cautions on Storing Discs	3
Cleaning Discs	3
About the Remote Control Unit	3
Inserting the Batteries	3
Operating Range of the Remote Control Unit	3
Part Names and Functions	4
Front Panel	4
Rear Panel	4
Display	4
Remote Control Unit	5

Connections

Preparations	5
Cables Used for Connections	5
Analog Connections	6
Digital Connections	6
USB Port Connections	6
USB Memory device	6
iPod	6
Connecting the Power Cord	6
Once Connections are Completed	6
Turning the Power On	6

Playback

Preparations	7
Before Playing a Disc	7
Before Playing a USB or iPod	7
Operations Possible During Playback	7
Switching the Display's Brightness	7
Listening with Headphones	7
Switching the Pure Direct Mode	7
CD Playback	8
Playing CDs	8
Switching the Display	8
Playing Repeatedly <Repeat Playback>	8
Repeated playback of parts you want to play	
<A-B repeat play>	8
Playing Random Order <Random Playback>	9
Playing Tracks in the Desired Order <Program playback>	9
Changing the playing speed <Pitch control playback>	9
Playback of MP3 and WMA Files	9
About the MP3 and WMA Formats That Can be Played	9
Playing MP3 and WMA Files	10
iPod® Playback	11
Disconnecting the iPod	11
USB Playback	11
Playable USB Memory Formats	11
Playing USB Memory device	12
Using the Timer Play Function	12

Troubleshooting 13

Specifications 14

Index 14

Getting Started

Thank you for purchasing this DENON product. To ensure proper operation, please read this owner's manual carefully before using the product.

After reading them, be sure to keep them for future reference.

Main Features

- AL24 Processing and High-precision 24bit D/A Converter**
Equipped with AL24 Processing, DENON's own analog waveform reproduction technology.
The reproducibility of weak signals is enhanced by expanding 16 bit digital data to 24 bit.
Also equipped with a high-performance, 24 bit/192 kHz-compatible D/A Converter for analog signal conversion of the digital data expanded with AL24 Processing.
- USB and iPod Direct playback**
A USB port is mounted on the Front Panel. MP3/WMA files can be played by connecting a USB Player or USB memory device. An iPod is connected using the USB cable supplied with the iPod. Music files in an iPod, USB Player or USB memory device are transmitted via digital signal and can be enjoyed at high audio quality using the DCD-710AE's own audio circuitry.
- Large 16-character / 2-line display**
Text information appears on the large display during MP3 or iPod playback.
- Pitch Control function**
The CD playback pitch can be adjusted in 0.1 % steps up to ±12 %. (Only during CD playback)

Accessories

Check that the following parts are supplied with the product.

- ① Owner's manual..... 1
- ② Service station list..... 1
- ③ Remote control unit (RC-1133) 1
- ④ R03/AAA batteries..... 2
- ⑤ Audio cable (Cord length: Approx. 1.0 m) 1

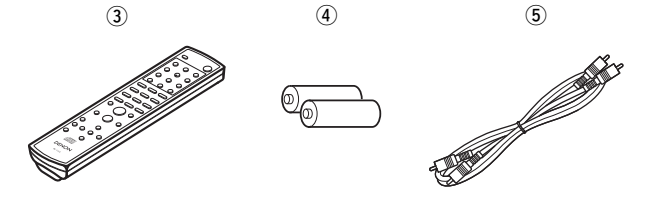

Cautions on Handling

• Before turning the power switch on

Check once again that all connections are correct and that there are no problems with the connection cables.

• When traveling or leaving home for long periods of time, be sure to unplug the power cord from the power outlet.

• Sufficiently ventilate the place of installation

If the unit is left in a room full of the smoke from cigarettes, etc., for long periods of time, the surface of the optical pickup could get dirty, in which case it will not be able to read the signals properly.

• About condensation

If there is a major difference in temperature between the inside of the unit and the surroundings, condensation (dew) may form on the operating parts inside the unit, causing the unit not to operate properly.

If this happens, let the unit sit for an hour or two with the power turned off and wait until there is little difference in temperature before using the unit.

• Cautions on using mobile phones

Using a mobile phone near this unit may result in noise. If so, move the mobile phone away from this unit when it is in use.

• Moving the unit

Turn off the power and unplug the power cord from the power outlet.

Next, disconnect the connection cables to other system units before moving the unit.

• Note that the illustrations in these instructions may differ from the actual unit for explanation purposes.

Discs

Discs Usable on the DCD-710AE

① Music CDs

Discs marked with the logotype below can be played in this unit.



② CD-R/CD-RW

NOTE

- Discs with special shapes (heart-shaped discs, octagonal discs, etc.) cannot be played. Do not attempt to play them, as doing so can damage the product.
 - Some discs and some recording formats may not be playable.
 - Non-finalized discs cannot be played.
- ※ What is finalization?
Finalization is the process that makes recorded CD-R/CD-RW discs playable on compatible players.



Holding Discs



Do not touch the signal surface.

Loading Discs

- Set the disc with the labeled side facing up.
- Make sure the disc tray is fully open when inserting the disc.
- Place the discs flatly, 12 cm discs in the outer tray guide (Figure 1), 8 cm discs in the inner tray guide (Figure 2).

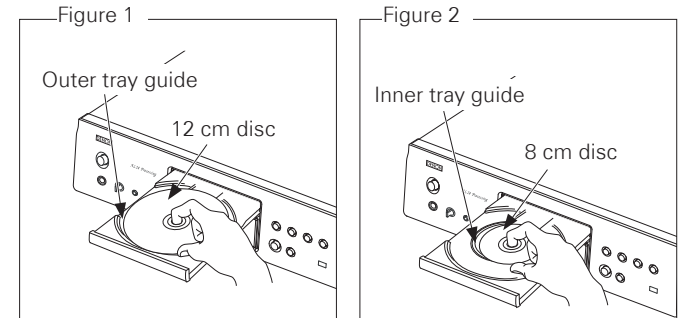

- Place 8 cm discs in the inner tray guide without using an adapter.



- "00 Tr 00 : 00" is displayed if a disc that cannot be played is loaded.
- "NO DISC" is displayed if the disc is loaded upside-down or if no disc is loaded.

NOTE

Do not push the disc tray in by hand when the power is turned off. Doing so could damage the set.

Cautions on Loading Discs

- Only load one disc at a time. Loading two or more discs can damage the unit or scratch the discs.
- Do not use cracked or warped discs or discs that have been repaired with adhesive, etc.
- Do not use discs on which the sticky part of cellophane tape or labels is exposed or on which there are traces of where labels have been removed. Such discs can get caught inside the player and damage it.

Cautions on Handling

- Do not get fingerprints, oil or dirt on discs.
- Take special care not to scratch discs when removing them from their cases.
- Do not bend or heat discs.
- Do not enlarge the hole at the center.
- Do not write on the labeled (printed) surface with ball-point pens, pencils, etc., or stick new labels on discs.
- Water droplets may form on discs if they are moved suddenly from a cold place (outdoors for example) to a warm place, but do not try to dry them off using a hairdryer, etc.

Cautions on Storing Discs

- Be sure to remove discs after using them.
- Be sure to store discs in their cases to protect them from dust, scratches, warping, etc.
- Do not store discs in the following places:
 1. Places exposed to direct sunlight for long periods of time
 2. Dusty or humid places
 3. Places exposed to heat from heating appliances, etc.

Cleaning Discs

- If there are fingerprints or dirt on discs, wipe them off before using the disc. Fingerprints and dirt can impair sound quality and cause interruptions in playback.
- Use a commercially available disc cleaning set or a soft cloth to clean discs.

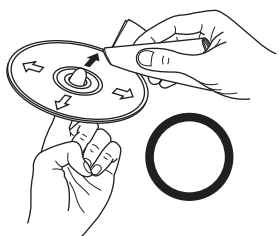

Gently wipe the disc from the inside towards the outside.

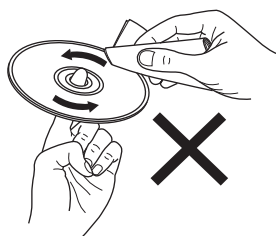

Do not wipe with a circular motion.

NOTE

Do not use record spray, antistatic agents, or benzene, thinner or other solvents.

About the Remote Control Unit

Inserting the Batteries

- ① Remove the remote control unit's rear cover.
- ② Set two R03/AAA batteries in the battery compartment in the indicated direction.
- ③ Put the rear cover back on.

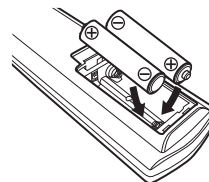
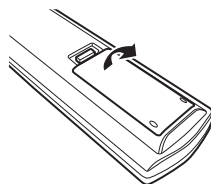

NOTE

- Replace the batteries with new ones if the set does not operate even when the remote control unit is operated close to the unit.
- The supplied batteries are only for verifying operation.
- When inserting the batteries, be sure to do so in the proper direction, following the "⊕" and "⊖" marks in the battery compartment.
- To prevent damage or leakage of battery fluid:
 - Do not use a new battery together with an old one.
 - Do not use two different types of batteries.
 - Do not attempt to charge dry batteries.
 - Do not short-circuit, disassemble, heat or dispose of batteries in flames.
- If the battery fluid should leak, carefully wipe the fluid off the inside of the battery compartment and insert new batteries.
- Remove the batteries from the remote control unit if it will not be in use for long periods.
- Used batteries should be disposed of in accordance with the local regulations regarding battery disposal.

Operating Range of the Remote Control Unit

Point the remote control unit at the remote sensor when operating it.

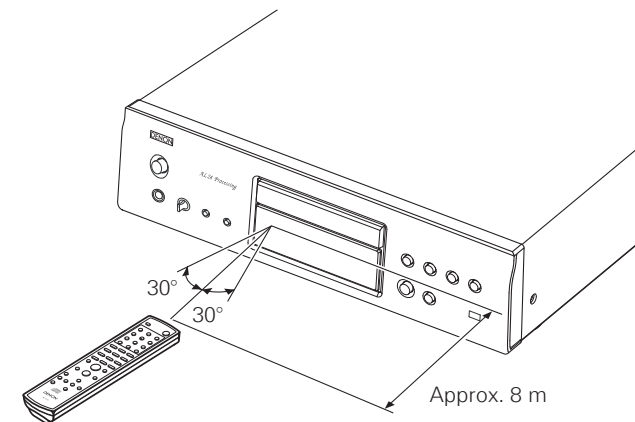

NOTE

The set may function improperly or the remote control unit may not operate if the remote control sensor is exposed to direct sunlight, strong artificial light from an inverter type fluorescent lamp or infrared light.

Part Names and Functions

For buttons not explained here, see the page indicated in parentheses ().

Front Panel

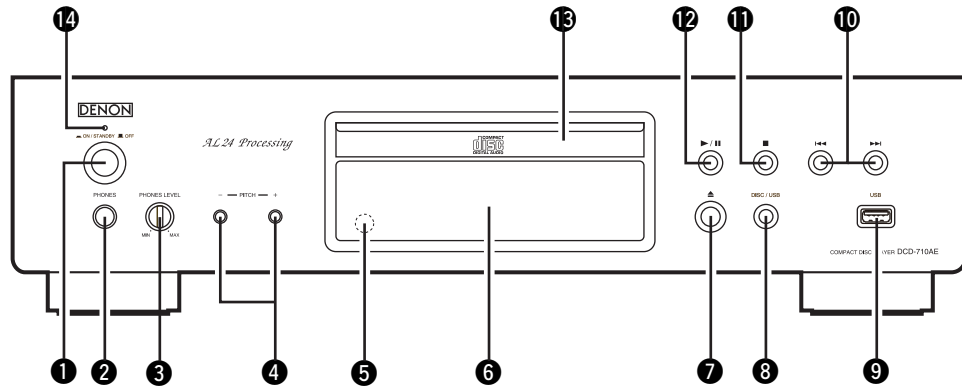

- ❶ Power switch (ON/STANDBY OFF) (7)
- ❷ Headphones jack (PHONES) (7)
- ❸ PHONES LEVEL knob (7)
- ❹ Pitch control button (PITCH +/-) (9)
- ❺ Remote control sensor (3)
- ❻ Display (4)
- ❼ Disc tray open/close button (7)
- ❽ Playback media mode button (DISC/USB) (7)
- ❾ USB port (USB) (6)
- ❿ Reverse-skip/Forward-skip buttons (I◀▶I) (8, 10)
- ⓫ Stop button (■) (8)
- ⓬ Play/Pause button (▶||) (7 ~ 10)
- ⓭ Disc tray (7)
- ⓮ Power indicator (7)
 - Power "ON" (Green)
 - Standby (Red)
 - Power "OFF" (Off)

Rear Panel

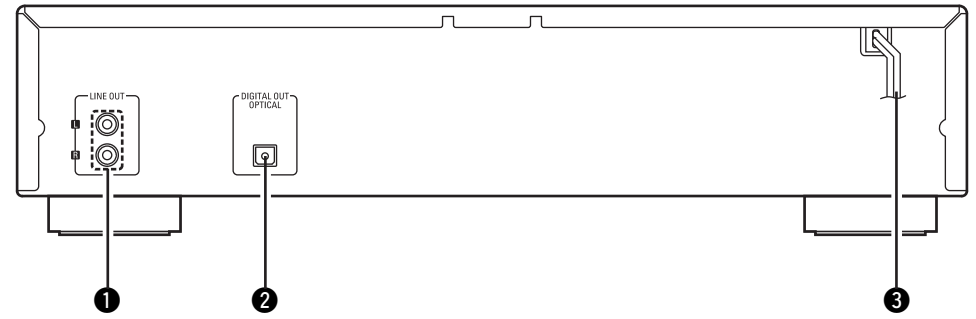

- ❶ LINE OUT connectors (6)
- ❷ DIGITAL OUT OPTICAL connector (6)
- ❸ Power cord (6)

Display

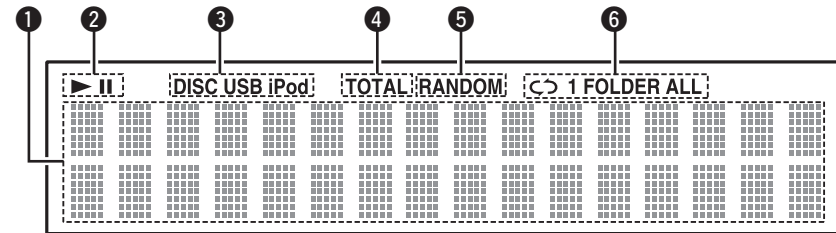

- ❶ Information display
Various information is displayed here, depending on the operation mode.
- ❷ Playback mode indicators
▶ : During Playback
|| : During pause
- ❸ Playback media indicators
- ❹ Total time indicator
Lights when the total number of tracks and total time of the CD are displayed.
- ❺ Random Playback indicators
- ❻ Repeat mode indicators
The display switches as follows each time the REPEAT button on the remote control unit is pressed.
 - In modes other than the folder mode:

▶ ↻ 1
↻ ALL

(1-track repeat) (All-track repeat)

Not displayed ←
 - In the folder mode:

▶ ↻ 1 FOLDER
↻ FOLDER

(1-track repeat) (All-track repeat between folders)

FOLDER ←

Remote Control Unit

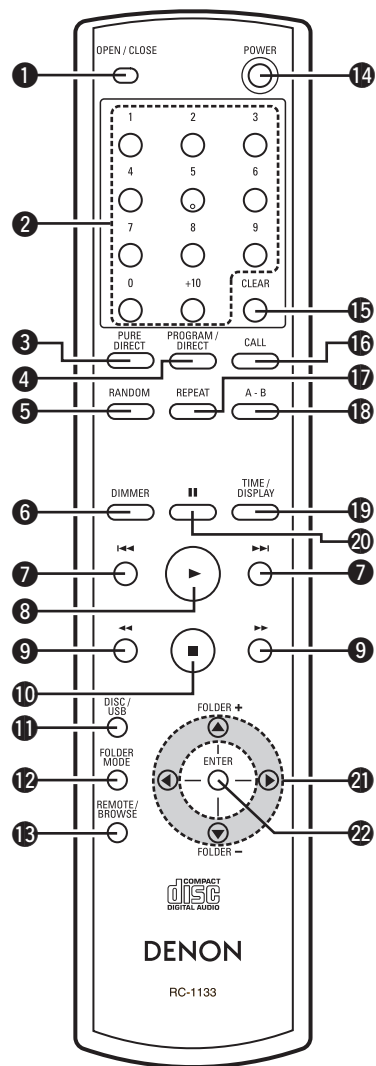

- 1 OPEN / CLOSE button (7)
- 2 Number buttons (8, 10)
- 3 PURE DIRECT button (7)
- 4 PROGRAM / DIRECT button (9)
- 5 RANDOM button (9)
- 6 DIMMER button (7)
- 7 Reverse-skip / Forward-skip buttons
(|<<< and >>>|) (8, 10, 12)
- 8 Play button (▶) (7 ~ 10)
- 9 Fast-reversing / Fast-forwarding buttons
(<<< and >>>) (8, 12)
- 10 Stop button (■) (8, 12)
- 11 Playback media mode button
(DISC / USB) (7)
- 12 FOLDER MODE button (10)
- 13 REMOTE / BROWSE button (11)
- 14 POWER button (7)
- 15 CLEAR button (9)
- 16 CALL button (9)
- 17 REPEAT button (8)
- 18 Repeat A-B button (A-B) (8)
- 19 TIME / DISPLAY button (8, 10, 11)
- 20 Pause button (||) (8, 12)
- 21 Cursor / FOLDER +, - buttons (10)
- 22 ENTER button (10)



The skip buttons (|<<< and >>>|), +10 button and FOLDER +, - buttons operate continuously when held in.

Connections

Connections for all compatible audio signal formats are described in this owner's manual. Please select the types of connections suited for the equipment you are connecting.

NOTE

- Do not plug in the power cord until all connections have been completed.
- When making connections, also refer to the owner's manual of the other components.
- Be sure to connect the left and right channels properly (left with left, right with right).
- Do not bundle power cords together with connection cables. Doing so can result in humming or noise.

Preparations

Cables Used for Connections

Select the cables according to the equipment being connected.

Audio cables

Analog connections (stereo)

(White) (L) (R)

(Red) (L) (R)

Audio cable (supplied)

Optical digital connections

Optical cable (sold separately)

iPod connections

iPod cable (sold separately)

Analog Connections

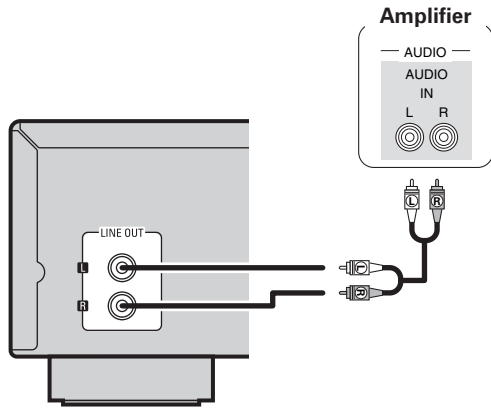

Digital Connections

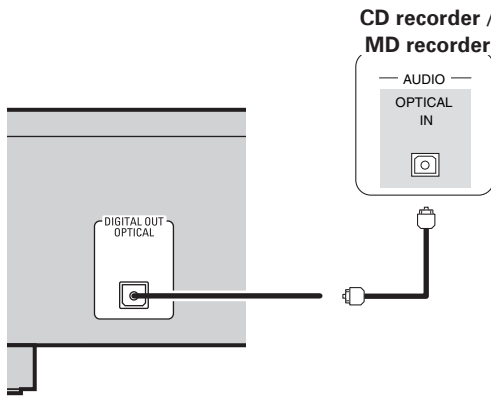

❑ When connecting the optical digital output connector with an optical transmission cable (sold separately)

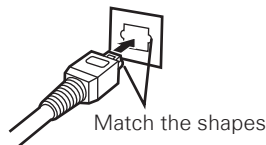

Match the shapes then insert firmly all the way in.

USB Port Connections

NOTE

- Do not use an extension cable when connecting a USB Memory device and an iPod.

USB Memory device

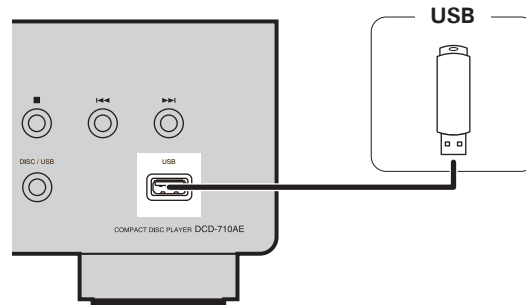

NOTE

- It is not possible to connect and use a computer via the DCD-710AE's USB port using a USB cable.
- For details about USB memory devices, see "Playable USB Memory Formats" (page 11).

iPod

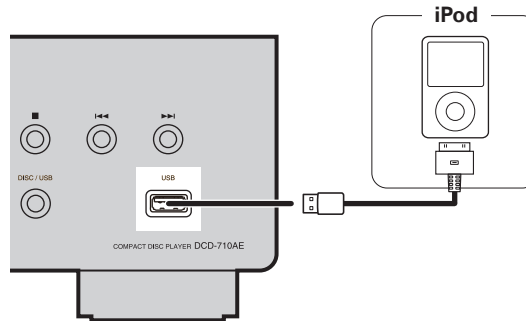

- To connect an iPod to the DCD-710AE, use the USB cable supplied with the iPod.
- For iPods, playback is possible on iPod touch, classic and nano sold from generation 5 on. For details, check the Web (www.denon.com).

Connecting the Power Cord

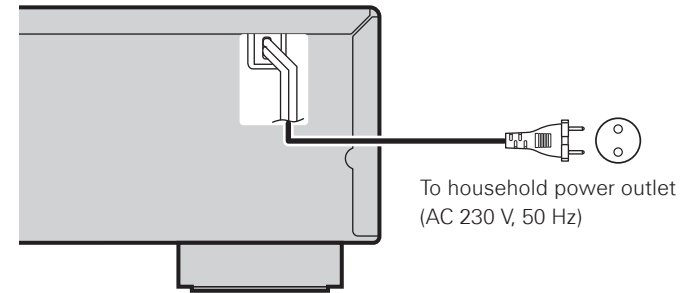

NOTE

- Insert the plugs securely. Incomplete connections will result in the generation of noise.
- Do not unplug the power cord while the set is operating.

Once Connections are Completed

Turning the Power On (page 7)

Playback

Symbols used to indicate buttons in this manual

- Button located on both the main unit and the remote control unit → **BUTTON**
- Button only on the main unit → **<BUTTON>**
- Button only on the remote control unit → **[BUTTON]**

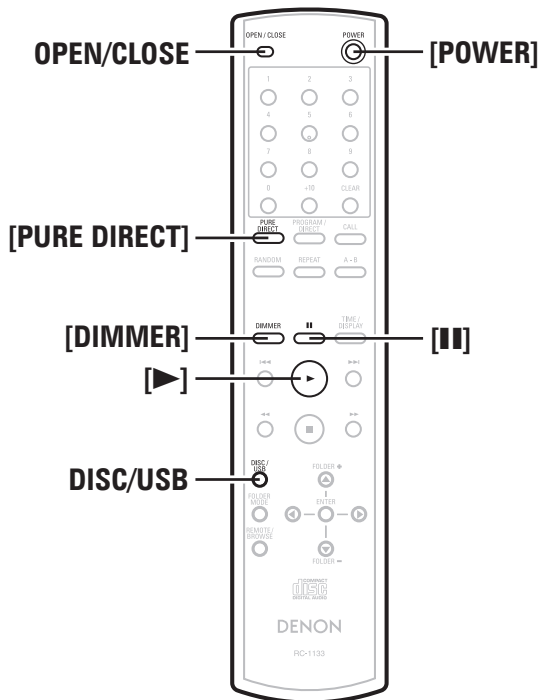
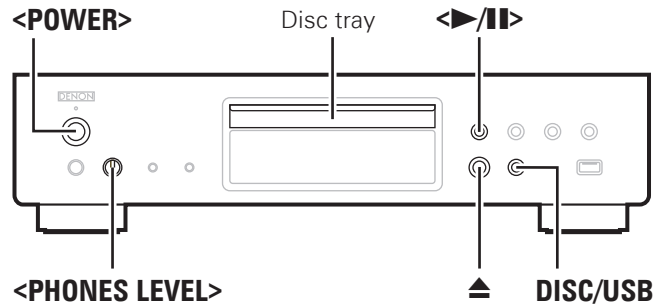

Preparations

Before Playing a Disc

- 1 Turn the DCD-710AE power on. (Press <POWER>).**
 - When a disc is loaded, playback starts automatically.
 - If no disc is loaded "NO DISC" is displayed.
- 2 Press DISC/USB to set the playback media mode to "DISC".**
- 3 Insert a disc.**
 - Press OPEN/CLOSE(▲) to open/close the disc tray.
 - The disc tray also closes when <▶/||>, [▶] or [||] is pressed.

NOTE

Do not place any foreign objects in the disc tray. Doing so could damage it.

Before Playing a USB or an iPod

- 1 Turn the DCD-710AE power on. (Press <POWER>).**
- 2 Connect USB memory device or iPod connection cable.**
 - When the USB memory device or iPod is connected to the USB port on the DCD-710AE, the source media mode automatically switches to "USB" and file playback begins.
 - The "USB" or "iPod" indicator lights up on the display.



The playback media mode setting remains in the memory, even when the power is set to standby.

Turning the Power Off

Press <POWER> again.

NOTE

- Be sure to stop playback before turning the power off.
- Make sure that the disc tray is completely shut before turning off the power.

Operations Possible During Playback

Switching the Display's Brightness

Press [DIMMER].

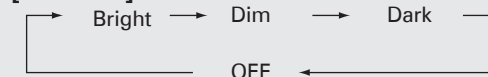

※ The display's brightness switches each time the button is pressed.

Listening with Headphones

Plug the headphones (sold separately) into the PHONES jack.

Adjusting the Volume

Turn <PHONES LEVEL>.

NOTE

To prevent hearing loss, do not raise the volume level excessively when using headphones.

Switching the Pure Direct Mode

In the stop mode, press [PURE DIRECT].

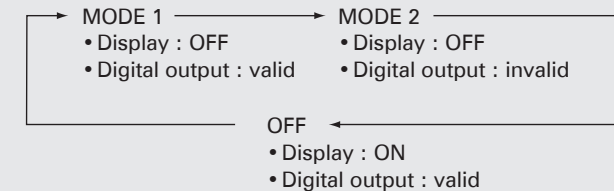

Playing Random Order <Random Playback>

1 In the stop mode, press [RANDOM].
The "RANDOM" indicator lights.

2 Press <▶/II> or [▶].
The tracks start playing in random order.

Stopping Random Playback
In the stop mode, press [RANDOM].
The "RANDOM" indicator turns off.



When [REPEAT] is pressed during random playback, the tracks are played in a different random order after this turn.

NOTE

Direct searching is not possible during random playback.

Playing Tracks in the Desired Order <Program playback>

Up to 25 tracks can be programmed.

1 In the stop mode, press [PROGRAM/DIRECT].
"PGM" is displayed.

2 Use [NUMBER] (0 ~ 9, +10) to select the tracks.

[Example] To program tracks 3, 12, 7 to play in that order:
Press [PROGRAM/DIRECT], [3], [+10], [2], [7].

3 Press <▶/II> or [▶].
Playback starts in the programmed order.

Checking the order of the programmed tracks
In the stop mode, press [CALL].
The track numbers are displayed in the programmed order each time the button is pressed.

To clear the last track programmed
In the stop mode, press [CLEAR].
The last track programmed is cleared each time the button is pressed.

To clear one programmed track at a time
In the stop mode, press [CALL] to select the track to be cleared, then press [CLEAR].

Clearing the all programmed track
In the stop mode, press [PROGRAM/DIRECT].



- When [REPEAT] is pressed during program playback, the tracks are played repeatedly in the programmed order.
- When [RANDOM] is pressed during program playback, the programmed tracks are played in random order.

Changing the playing speed <Pitch control playback>

The playing speed can be speeded up or slowed down.

Press <PITCH +> or <PITCH ->.

The amount of change is displayed.

※ The playing speed can be changed within the range of -12.0% to +12.0%.

Canceling pitch control
Press <PITCH +> and <PITCH -> simultaneously, or Press OPEN/CLOSE(▲) to open the disc tray..



- Pitch control playback is not possible in the pure direct mode.
- No data is output from the optical digital output terminal during pitch control playback. To output data, return to the normal playing speed.
- The time is not displayed accurately during pitch control playback.
- When the speed is changed, the pitch also changes.
- The pitch control function cannot be used with MP3, WMA and iPod files.

Playback of MP3 and WMA Files

There are many music distribution sites on the Internet allowing you to download music files in MP3 or WMA (Windows Media® Audio) format. The music (files) downloaded from such sites can be stored on CD-R or CD-RW discs and played on the DCD-710AE.

"Windows Media" and "Windows" are registered trademarks or trademarks in the United States and other countries of Microsoft Corporation of the United States.

About the MP3 and WMA Formats That Can be Played

CD-R and CD-RW discs created in the format described below can be played.

Writing software format

ISO9660 level 1

※ When written in other formats, it may not be possible to play the disc properly.

Maximum number of playable files and folders

Total number of folders and files : 512

Number of folders : 256

File format

MPEG-1 Audio Layer-3

WMA (Windows Media Audio)

Tag data

ID3-Tag (Ver. 1.x and 2.x)

META-Tag

(Compatible with title, artist and album names)

Playable MP3/WMA file			
File format	Sampling frequency	Bit rate	Extension
MP3	32, 44.1, 48 kHz	32 ~ 320 kbps	.mp3
WMA	32, 44.1, 48 kHz	64 ~ 192 kbps	.wma



- Be sure to give files the extension ".MP3" or ".WMA". Files with any other extensions or with no extensions cannot be played.
- Recordings you have made should only be used for your personal enjoyment, and as per copyright laws may not be used in other ways without permission of the copyright holder.

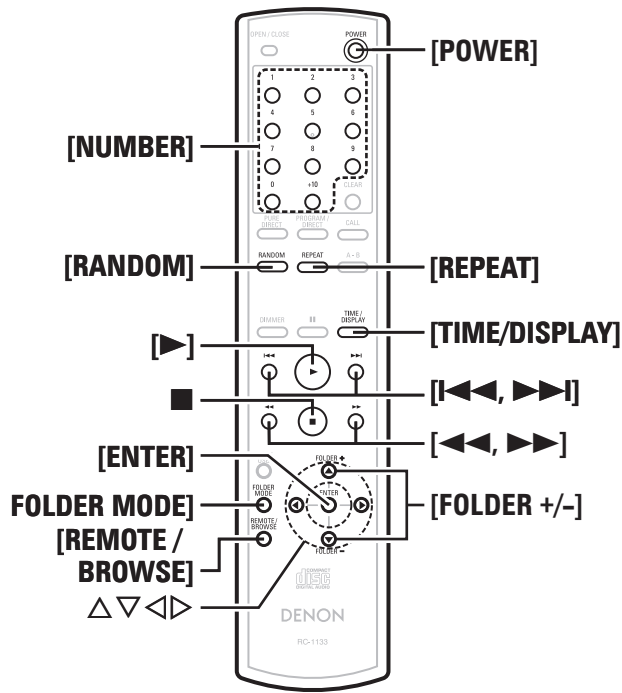
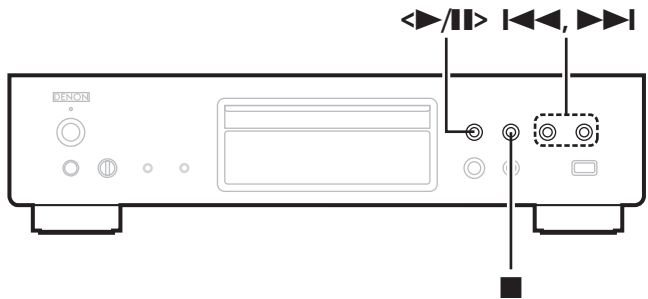
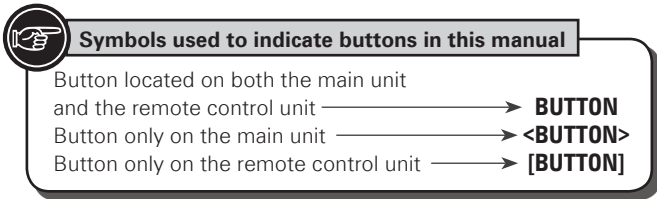

Playing MP3 and WMA Files

- 1 Load a CD-R or CD-RW disc containing music files in the MP3 or WMA format into the disc tray (page 2).**
- 2 Press [FOLDER MODE] and select “Folder Mode” or “Disc Mode”.**
 [About the display]
 When “Folder Mode” is selected “FOLDER” indicator lights.
 When “Disc Mode” is selected “FOLDER” indicator turns off.
Folder Mode :
 All the files in the selected folder are played.
Disc Mode :
 After the selected folder and files are played, all the files in all the folders are played.
- 3 Use [FOLDER +, -] to select the folder to be played.**
- 4 Use [LEFT], [RIGHT] or [LEFT], [RIGHT] to select the file to be played.**
- 5 Press [PAUSE] or [STOP].**

To switch the Folder or File During Playback

- Folder**
Use [FOLDER +, -] to select the folder, then press [ENTER].
- File**
Use [LEFT], [RIGHT] to select the file, then press [ENTER].
Also use [LEFT], [RIGHT] to select the file, or use [NUMBER] (0 ~ 9, +10) to select the file number.

※ The file numbers are set automatically when the disc is loaded.



Copyright-protected files cannot be played.
 (The “Not Support” is displayed.)
 Note that depending on the software used for burning and other conditions, some files may not play or display correctly.

Switching the Display

During playback, press [TIME/DISPLAY].

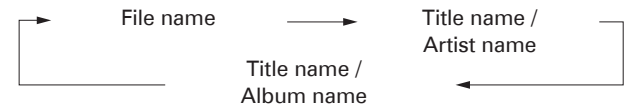

※ The characters that can be displayed are as follows:

A ~ Z a ~ z 0 ~ 9

! " # \$ % & : ; < > ? @ \ [] _ ` | { } ~ ^ ' () * + , - . / = (space)

To Play Repeatedly

Press [REPEAT].

Playback starts in the respective repeat mode.

※ The selectable repeat modes differ in the “Folder Mode” and the “Disc Mode”.

When “Folder Mode” is selected:

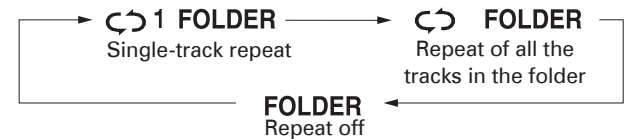

When “Disc Mode” is selected:

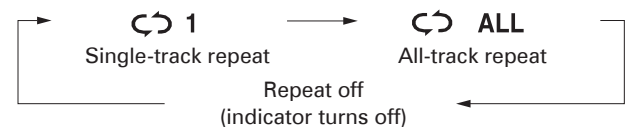

[Selectable items]

When “Folder Mode” is selected:

[1 FOLDER] : Only the selected track is played repeatedly.

[FOLDER] : All the files in the selected folder are played repeatedly.

[FLDER] : Folder mode playback resumes.

When “Disc Mode” is selected:

“Playing Repeatedly <Repeat playback>” (page 8)

Setting random playback

“Playing Random Order <Random playback>” (page 9)



Programmed playback is not possible with MP3/WMA discs.

iPod® Playback

With the DCD-710AE, you can listen to music on an iPod. It is also possible to operate the iPod from the main unit or remote control unit.



“Made for iPod” means that an electronic accessory has been designed to connect specifically to iPod and has been certified by the developer to meet Apple performance standards. Apple is not responsible for the operation of this device or its compliance with safety and regulatory standards. iPod is a trademark of Apple Inc., registered in the U.S. and other countries.

※ The iPod may only be used to copy or play contents that are not copyrighted or contents for which copying or playback is legally permitted for your private use as an individual. Be sure to comply with applicable copyright legislation.

1 Playback preparation (“Before Playing USB or iPod” page 7).

2 Press [REMOTE/BROWSE] to select the display mode.

The mode switches each time the button is pressed.

[Selectable mode]		Browse mode	Remote mode
Display location		Main unit display	iPod display
Playable files	Audio file	○	○
	Video file	×	○
Active buttons	Remote control unit and Main unit (DCD-710AE)	○	○
	iPod	×	○

3 Use [△▽] to select the item, then press [ENTER] or [▷] to select the music file to be played.

4 Press <▶/⏸> or [▶]. Playback starts.

Remote control and iPod button relations

Remote control unit buttons	iPod buttons	Operation on the DCD-710AE
▶	⏸	Play the track. ※ Play/Pause in remote mode
⏮, ⏭	⏮, ⏭	Play the track from the beginning/ Play the next track.
⏪, ⏩	⏮, ⏭ Press and hold	Fast-reverse the track/Fast-forward the track.
△, ▽	Click Wheel	Select an item.
ENTER or ▷	Select	Enter the selection or plays the track.
REMOTE/BROWSE	-	Switch between the browse mode and the remote mode.
REPEAT	-	Switch the repeat function
RANDOM	-	Switch the shuffle function
◀	MENU	Display the menu or return to the previous menu.

NOTE

- DENON will accept no responsibility whatsoever for any loss of iPod data.
- Depending on the type of iPod and the software version, some functions may not operate.

To Switch the Display

During playback, press [TIME/DISPLAY].

The display switches each time the button is pressed.

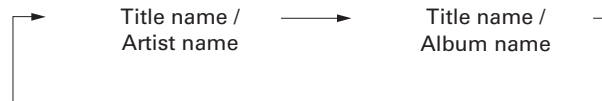

Disconnecting the iPod

1 Press [POWER] to set the standby mode.

2 Disconnect the iPod cable from the USB port.

USB Playback

Playable USB Memory Formats

Files stored on USB memory devices created in the formats below can be played.

USB-Compatible File Systems

“FAT16” or “FAT32”

※ If the USB memory device is divided into multiple partitions, only the top drive can be selected.

Maximum number of playable files and folders

Maximum number of files in a folder: 255

Maximum number of folders: 255

File Format

MPEG-1 Audio Layer-3

WMA (Windows Media Audio)

Tag Data

ID3-Tag (Ver.1.x and 2.x)

META-Tag

(Compatible with title, artist and album names)

Playable MP3/WMA file			
File format	Sampling frequency	Bit rate	Extension
MP3	32, 44.1, 48 kHz	32 ~ 320 kbps	.mp3
WMA	32, 44.1, 48 kHz	64 ~ 192 kbps	.wma



Only music files that are not copyright-protected can be played on this set.

※ Contents downloaded from pay sites on the Internet are copyright protected. Also, files encoded in WMA format when ripped from a CD, etc., on a computer may be copyright protected, depending on the computer's settings.

Playing USB Memory device

1 Playback preparation (“Before Playing USB or iPod”
page 7).

2 Press **[FOLDER MODE]** and select “Folder Mode” or
“Memory Mode”.

[About the display]

When “Folder Mode” is selected “FOLDER” indicator lights.
When “Memory Mode” is selected.. “FOLDER” indicator turns off.

Folder Mode :

All the files in the selected folder are played.

Memory Mode :

After the selected folder and files are played, all the files in all
the folders are played.

3 Use **[FOLDER +, -]** to select the folder to be played.

4 Use **[◀◀, ▶▶]** or **[◀, ▶]** to select the file to be
played.

5 Press **<▶/||>** or **[▶]**.

❑ To Switch the Folder or File During Playback

• **Folder**

Use **[FOLDER +, -]** to select the folder, then press **[ENTER]**.

• **File**

Use **[◀, ▶]** to select the file, then press **[ENTER]**.

Use **[◀◀, ▶▶]** to select the file, or use **[NUMBER] (0 ~ 9, +10)**
to select the file number.

※ The file numbers are set automatically when the USB memory
device is loaded.

❑ Stopping Playback

Press **■**.

❑ Stopping Playback Temporarily

Press **<▶/||>** or **[||]**.

The “||” is displayed.

※ To resume playback, press **<▶/||>** or **[▶]**.

❑ Fast-Forwarding and Fast-Reversing (searching)

During playback, press and hold in **[◀◀, ▶▶]**.

❑ Playing Repeatedly

Press **[REPEAT]**.

❑ Playing Random Order

In the stop mode, press **[RANDOM]**.

❑ Switching the Display

During playback, press **[TIME/DISPLAY]**.

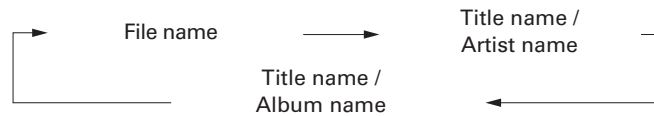

※ The characters that can be displayed are as follows:

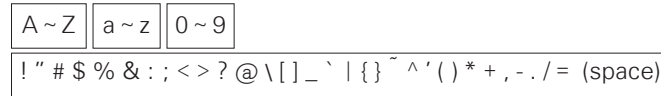

NOTE

- DENON will take no responsibility whatsoever for any loss or damage to data on USB memory devices when using the USB memory device connected to the DCD-710AE.
- USB memory devices will not work via a USB hub.
- DENON does not guarantee that all USB memory devices will operate or be supplied power. When using a USB connection type portable hard disk of the type for which power can be supplied by connecting an AC adapter, we recommend using the AC adapter.

Using the Timer Play Function

1 Turn on the power of the connected components.

2 Switch the amplifier’s function to input from the
connected main unit.

3 Load a disc or connect the USB memory device or
iPod.

4 Set the audio timer for the desired times.

※ Refer also to the owner’s manual of the audio timer.

5 Turn the timer “ON”.

The power of the components connected to the timer turns off.

※ When the set time is reached, the power of the different
components automatically turns on and playback starts from the
first track.

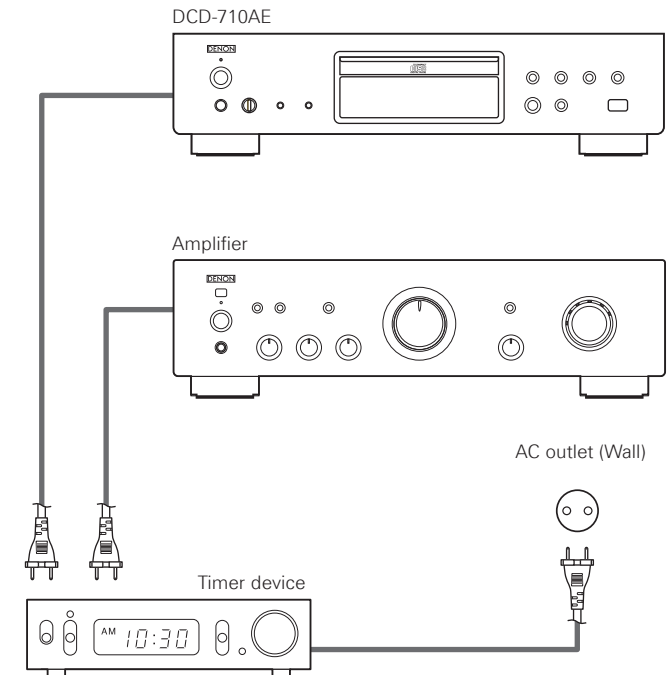

Troubleshooting

If a problem should arise, first check the following:

1. Are the connections correct?
2. Is the set being operated as described in the owner's manual?

If this unit does not operate properly, check the items listed in the table below. Should the problem persist, there may be a malfunction.

In this case, disconnect the power immediately and contact your store of purchase.

[General]

Symptom	Cause	Countermeasure	Page
Disc tray does not open.	• The power is not on.	• Turn on the power.	7
"NO DISC" is displayed even though a disc is loaded.	• The disc is not properly loaded.	• Reload the disc.	2
"00 Tr 00 : 00" is displayed even though a disc is loaded.	• The loaded disc is not a CD.	• Load a CD.	2
Playback does not start even when the ►/ button on the main unit or the ► button on the remote control unit is pressed.	• The disc is dirty or scratched.	• Wipe the dirt off the disc or replace the disc.	3
No sound is produced or sound is distorted.	• The output cables are not properly connected to the amplifier. • The amplifier's function setting or adjustments are not right.	• Check the connections. • Check the amplifier's function and controls and adjust as necessary.	6 -
Specific section of the disc cannot be played properly.	• The disc is dirty or scratched.	• Wipe the dirt off the disc or replace the disc.	3
Programmed playback is not possible.	• The tracks have not been programmed properly. • Programmed playback is not possible with MP3 and WMA files.	• Program properly.	9
		• Use a CD.	9
A CD-R or CD-RW disc cannot be played.	• The disc has not been finalized. • The recording conditions are bad or the quality of the disc itself is poor.	• Finalize the disc then play it.	2
		• Use a properly recorded disc.	2

Symptom	Cause	Countermeasure	Page
Set does not operate properly when remote control unit is operated.	• The batteries are spent.	• Replace the batteries with new ones.	3
	• The remote control unit is too far from the set.	• Move the remote control unit closer to the set.	3
"Not Support" is displayed when playing files recorded in MP3 or WMA format.	• You have selected a copyright-protected WMA file or a file that cannot be played normally.	• Use the ◀◀ or ▶▶ button to select a different file.	10

[iPod]

Symptom	Cause	Countermeasure	Page
iPod cannot be played.	• Cable is not properly connected.	• Reconnect.	6

[USB]

Symptom	Cause	Countermeasure	Page
When a USB memory device is connected, "USB" is not displayed.	• The set cannot recognize a USB memory device.	• Check the connection.	6
	• A USB memory device not conforming to mass storage class or MTP standards is connected. • A USB memory device that the set cannot recognize is connected.	• Connect a USB memory device conforming to mass storage class or MTP standards. • This is not a malfunction. DENON does not guarantee that all USB memory devices will operate or receive power.	- -
Files on a USB memory device cannot be played.	• USB memory device is connected via USB hub.	• Connect the USB memory device directly to the USB port.	-
	• USB memory device is in format other than FAT16 or FAT32.	• Set the format to FAT16 or FAT32. For details, refer to the USB memory device's operating instructions.	-
	• USB memory device is divided into multiple partitions.	• When divided into multiple partitions, only files stored in the top partition can be played.	-
	• Files are stored in a non-compatible format.	• Record the files in a compatible format.	11
	• You are attempting to play a file that is copyright protected.	• Files that are copyright protected cannot be played on this set.	11

Specifications

Audio performance

Analog output

Channels:	2 channels
Playable frequency range:	2 Hz ~ 20 kHz
S/N:	110 dB
Dynamic range:	105 dB
Harmonic distortion:	0.0025 % (1 kHz)
Wow & flutter:	Below measurable limits
Output level:	2.0 V (10 kΩ/kohms)
Signal type:	16-bit linear PCM
Sampling frequency:	44.1 kHz
Usable discs:	Compact Disc
Digital output	
Optical:	-15 ~ -21 dBm
Emission wavelength:	660 nm

General

Power supply:	AC 230 V, 50 Hz
Power consumption:	22 W
Maximum external dimensions:	434 (W) x 107 (H) x 279 (D) mm
Weight:	4.2 kg

Remote control unit (RC-1133)

Power supply:	R03/AAA Type (two batteries)
Maximum external dimensions:	49 (W) x 220 (H) x 21 (D) mm
Weight:	106 g (including batteries)

※ For purposes of improvement, specifications and design are subject to change without notice.

Index

A

A-B repeat play	8
All-track repeat	8
Analog Connections	6
Audio cable	5

B

Batteries	3
-----------	---

C

Cables Used for Connections	5
CD-R/CD-RW	2

D

Digital Connections	6
Display	4
Display's Brightness	7

E

Extension	9, 11
-----------	-------

F

Fast-Forwarding	8, 12
Fast-Reversing	8, 12
File format	9, 11
Folder	9, 11
Folder Mode	10

H

Headphones	7
------------	---

I

iPod	11
------	----

M

Moving to the Beginning of Tracks	8
MP3	9
Music CDs	2

O

Optical cable	5, 6
---------------	------

P

Playing CDs	8
Playing Random Order	9
Playing Repeatedly	8
Playing Tracks in the Desired Order	9
Power Cord	6
Program playback	9

R

Random Playback	9, 12
Repeat Playback	8, 12

S

Searching	8
Single-track repeat	8, 12
Skipping	8, 12
Stopping Playback	8, 12
Stopping Playback Temporarily	8, 12

T

Timer Play Function	12
---------------------	----

U

USB Memory Device	11
-------------------	----

W

WMA	9
-----	---

DENON

www.denon.com

Denon Brand Company, D&M Holdings Inc.
Printed in China 5411 10314 008D